

Stone

25.03.2019

Cotes en mm

**PROFONDEUR
70**

90



100



120



140



160

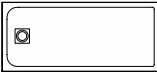

170

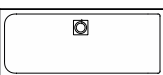

**PROFONDEUR
80**

80



100

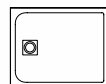

120

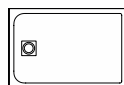

140

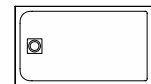

160

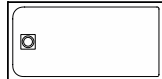

170



**PROFONDEUR
90**

90



100

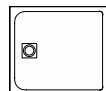

120

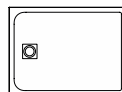

140

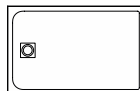

160



**PROFONDEUR
100**

100

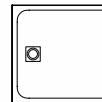

120

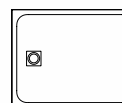

140

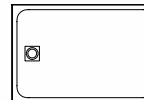

160

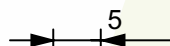
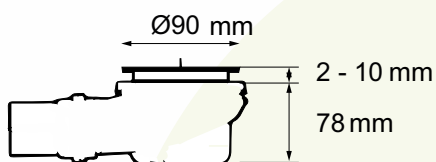

Arrondi

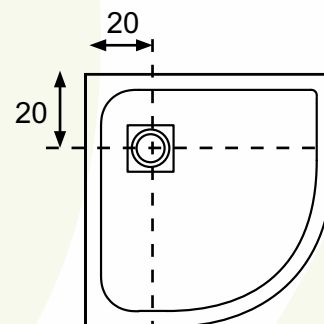
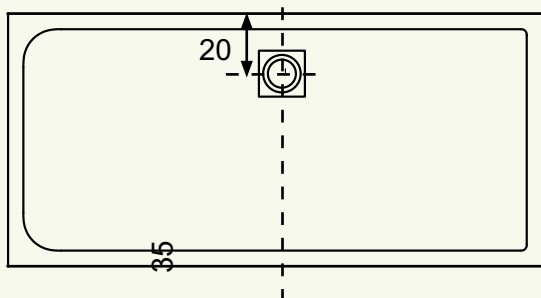
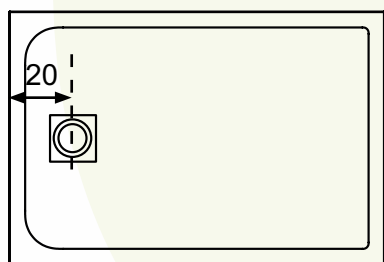
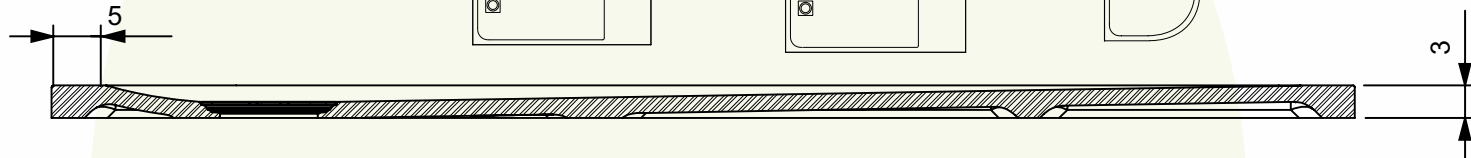
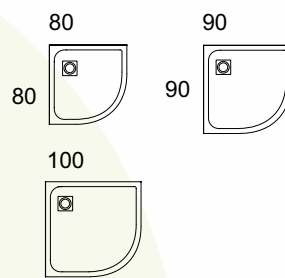

Sous réserve de modifications techniques, de tolérances et d'erreurs liées à la fabrication. La responsabilité ne peut être engagée en cas de cotes manquantes ou erronées.